

Section 295 - Black



450 Blandford Road
Poole
Dorset
United Kingdom
BH16 5BN

General description: Metallic non-skid step nosing filled with black carborundum

MOD NSN Procurement reference:

2090-99-345-8015: length 720mm (Part number: S295B720)

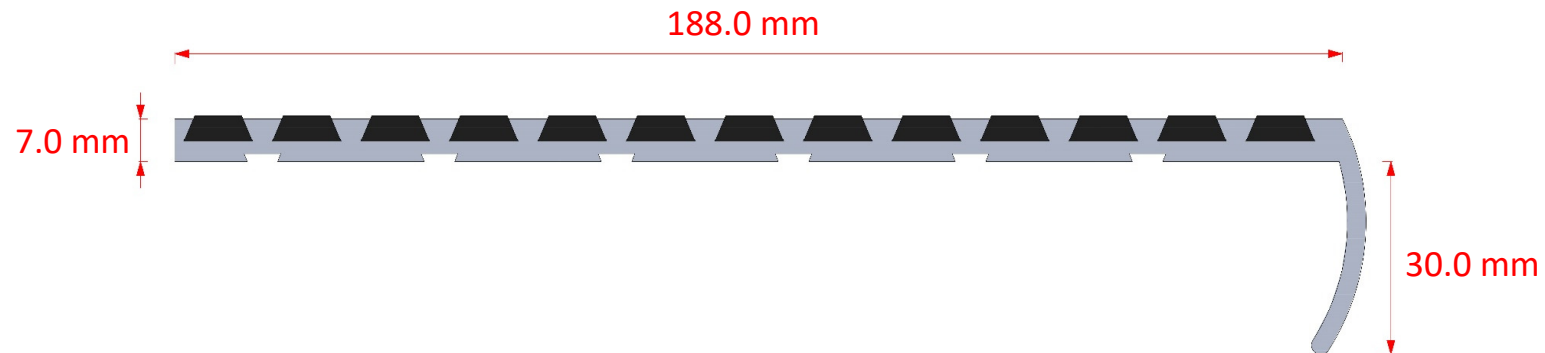

Carborundum non slip material meeting:
BS 476-6 Fire propagation (Test P1)
BS 476-7 Surface spread of flame (test P2)
ISO 19702 Smoke and Toxicity (Tests P5 & P6)

Section 295 - Black



450 Blandford Road
Poole
Dorset
United Kingdom
BH16 5BN

General description: Metallic non-skid step nosing filled with black carborundum

MOD NSN Procurement reference:

2090-99-345-8015: length 720mm (Part number: S295B720)

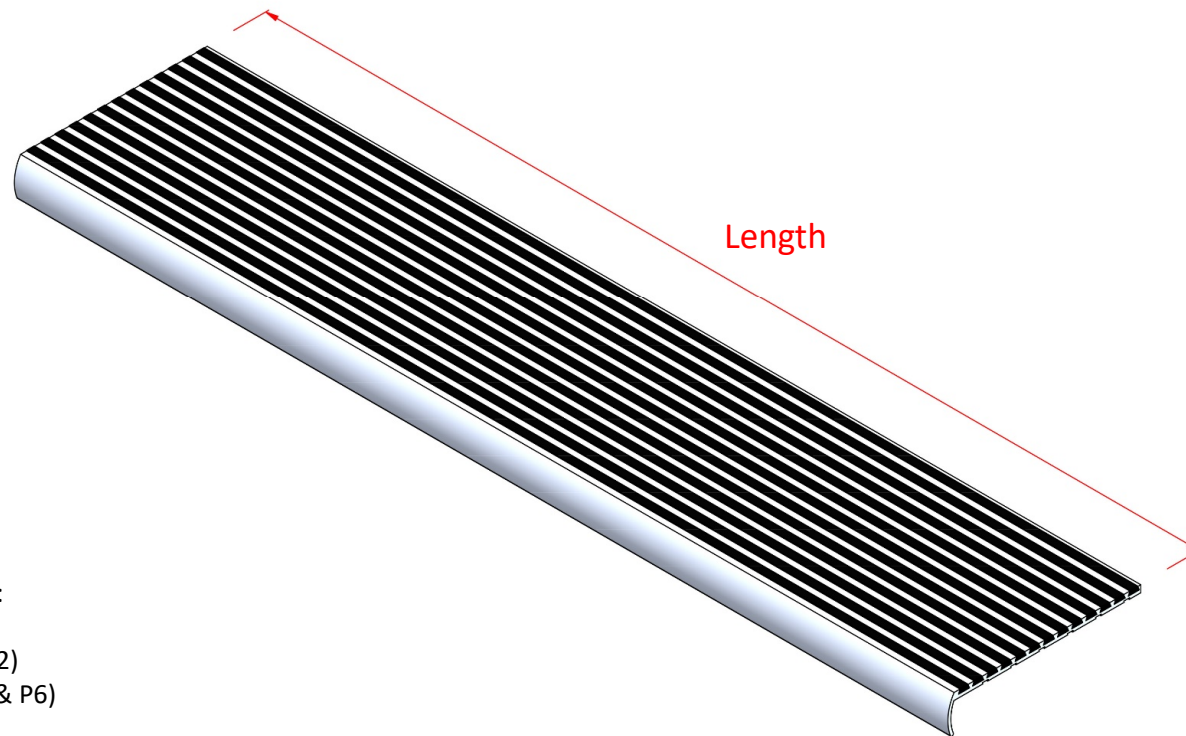

Carborundum non slip material meeting:
BS 476-6 Fire propagation (Test P1)
BS 476-7 Surface spread of flame (test P2)
ISO 19702 Smoke and Toxicity (Tests P5 & P6)